

TQ6602 GEN2

WIRELESS ACCESS POINTS

AT-TQ6602 GEN2

AT-TQm6602 GEN2

802.11ax Dual-radio 5G/2.4GHz 4x4+4x4 Wireless AP

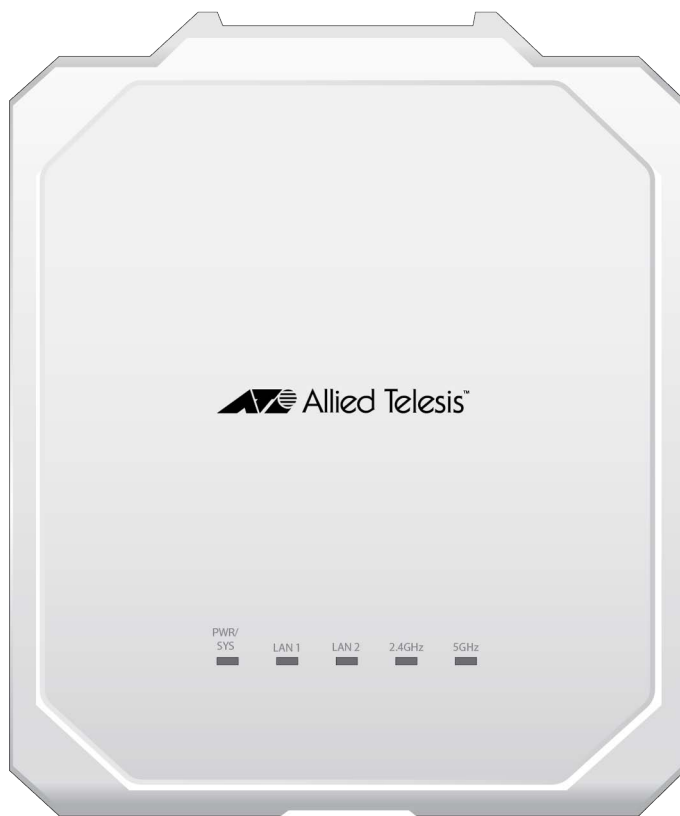

6007

Installation Guide

Copyright © 2025 Allied Telesis, Inc.

All rights reserved. No part of this publication may be reproduced without prior written permission from Allied Telesis, Inc.

Allied Telesis and the Allied Telesis logo are trademarks of Allied Telesis, Incorporated. All other product names, company names, logos or other designations mentioned herein are trademarks or registered trademarks of their respective owners.

Allied Telesis, Inc. reserves the right to make changes in specifications and other information contained in this document without prior written notice. The information provided herein is subject to change without notice. In no event shall Allied Telesis, Inc. be liable for any incidental, special, indirect, or consequential damages whatsoever, including but not limited to lost profits, arising out of or related to this manual or the information contained herein, even if Allied Telesis, Inc. has been advised of, known, or should have known, the possibility of such damages.

Contents

Preface	9
Safety Symbols Used in this Document	10
Translated Safety Statements	11
Contacting Allied Telesis	12
Chapter 1: Product Description	13
Hardware Components	14
Cable Hide	16
Console Port	16
Power Switch	16
Kensington Lock Hole	16
Reset Button	16
LAN1 and LAN2 Ports	18
Static Link Aggregation	18
Cascade Mode	19
Power Over Ethernet Plus (PoE+)	20
Connector Type	20
Speed	20
Duplex Mode	20
Automatic MDIX Detection	20
Cable Requirements	21
Maximum Distance	21
Port Pinouts	21
Guidelines	21
AC Adapter for External Power Supply	22
LEDs	23
Chapter 2: Installing the Wireless Access Point	25
Reviewing Safety Precautions	26
Unpacking the Shipping Box	29
Reviewing Installation Guidelines	30
Installing the Access Point on a Table	32
Overview to Installing the Access Point on a Wall or Ceiling	33
Pre-fitting the Mounting Bracket on the Access Point	34
Installing the Mounting Bracket on a Wall or Ceiling	36
Connecting Ethernet Cables to LAN1 and LAN2 Ports	40
Guidelines	40
Connecting the Ethernet Cables to LAN Ports	40
Connecting the AC Power Adapter	42
Attaching the Access Point to the Mounting Bracket	43
Installing an Anti-theft Device	46
Starting the First Management Session	47
Appendix A: Technical Specifications	49
Physical Specifications	49
Environmental Specifications	49
Power Specifications	50
External AC Adapter Specifications	50

- PoE+ Power Requirements 50
- Cable Specifications 51
- LAN Ports Specifications and Pinouts 52
 - Port Specifications 52
 - Port Pinouts..... 52
- Appendix B: Regulatory Statements 53**
 - Federal Communication Commission Interference Statement 54
 - European Union Restriction of the Use of Certain Hazardous Substances (RoHS) in Electrical and Electronic Equipment 56
 - Industry Canada Statement..... 57
 - UK - UKCA Declaration of Conformity 59
 - Operating Frequencies and Maximum Transmission Power Levels 59
 - Radiation Exposure Statement 59
 - Importer..... 59
- Appendix C: Radiation Patterns 61**
 - TQ6602 GEN2 and TQm6602 GEN2 Access points 62
 - Antenna Locations 62
 - Axes on the Access Point 62
 - 4x4 2.4G..... 63
 - 4x4 5G..... 64

Figures

Figure 1: TQ6602 GEN2 and TQm6602 GEN2 Access Point Top View	14
Figure 2: Access Point Bottom View	15
Figure 3: Front Edge View	15
Figure 4: Back Edge View	15
Figure 5: Left Edge View	16
Figure 6: LAN1 and LAN2 Ports in a Static LAG	18
Figure 7: LAN2 Port in Cascade Mode with an End Node	19
Figure 8: LAN2 Port in Cascade Mode with a Networking Device	19
Figure 9: PWRADP-01 (DA-48Z12) Power Adapter	22
Figure 10: TQ6602 GEN2 and TQm6602 GEN2 Access Points' LEDs	23
Figure 11: Shipping Box Components	29
Figure 12: Approved Installation Orientations on a Ceiling, Wall, or Table	31
Figure 13: Attaching the Bracket Screws to the Access Point	34
Figure 14: Panel Screw	34
Figure 15: Attaching the Mounting Bracket on the Access Point	35
Figure 16: Removing the Mounting Bracket from the Access Point	35
Figure 17: Marking the Holes for the Key-Hole Slots	36
Figure 18: Installing Two Screws	37
Figure 19: Installing the Mount Bracket On the Screws	38
Figure 20: Pre-Drill Holes on Mounting Bracket	38
Figure 21: Securing the Mount Bracket	39
Figure 22: Connecting an Ethernet Cable to the LAN1 Port	40
Figure 23: Connecting the Ethernet Cable to the LAN2 Port	41
Figure 24: Connecting an AC Power Adapter to the Access Point	42
Figure 25: Installing the Access Point on the Mounting Bracket	43
Figure 26: Seating the Access Point on the Mounting Bracket	44
Figure 27: Tightening the Mounting Bracket Thumbscrew	44
Figure 28: Fitting the Cables in the Cable Hide	45
Figure 29: Kensington Lock Port Location	46
Figure 30: Login Prompt	47
Figure 31: Pin Layout for RJ45 Connector on LAN Port	52
Figure 32: Antenna Axes on the TQ6602 GEN2 and TQm6602 GEN2 Access Points	62
Figure 33: Axes on the TQ6602 GEN2 and TQm6602 GEN2 Access Points	62

Tables

Table 1. LED Status Information	23
Table 2. Physical Specifications	49
Table 3. Environmental Specifications	49
Table 4. External AC/DC Adapter Specifications	50
Table 5. PoE+ Power Specifications on LAN Ports	50
Table 6. LAN Port Specifications	52
Table 7. Pin Signals for 100M/1G/2.5G/5G Base-T Connectors	52

Preface

This guide contains the hardware installation instructions for the TQ6602 GEN2 Access Points. The access point models included in this manual are:

- ❑ TQ6602 GEN2
- ❑ TQm6602 GEN2

This preface contains the following sections:

- ❑ “Safety Symbols Used in this Document” on page 10
- ❑ “Translated Safety Statements” on page 11
- ❑ “Contacting Allied Telesis” on page 12

Safety Symbols Used in this Document

This document uses the following conventions.

Note

Notes provide additional information.



Caution

Cautions inform you that performing or omitting a specific action may result in equipment damage or loss of data.



Warning

Warnings inform you that performing or omitting a specific action may result in bodily injury.



Warning

Warnings inform you of hot surfaces.

Translated Safety Statements

Important: The  indicates that a translation of the safety statement is available in a PDF document titled *Translated Safety Statements* on the Allied Telesis website at www.alliedtelesis.com/library.

Remarque: Les consignes de sécurité portant le symbole  sont traduites dans plusieurs langues dans le document *Translated Safety Statements*, disponible à l'adresse www.alliedtelesis.com/library.

Contacting Allied Telesis

If you need assistance with this product, visit Allied Telesis web site at **www.alliedtelesis.com/support**.

Chapter 1

Product Description

The sections in this chapter describe the hardware components of the TQ6602 GEN2 Wireless Access Points:

- ❑ “Hardware Components” on page 14
- ❑ “LAN1 and LAN2 Ports” on page 18
- ❑ “AC Adapter for External Power Supply” on page 22
- ❑ “LEDs” on page 23

Hardware Components

The top view of the TQ6602 GEN2 or TQm6602 GEN2 Access Point is illustrated in Figure 1.



Figure 1. TQ6602 GEN2 and TQm6602 GEN2 Access Point Top View
The bottom view is illustrated in Figure 2.

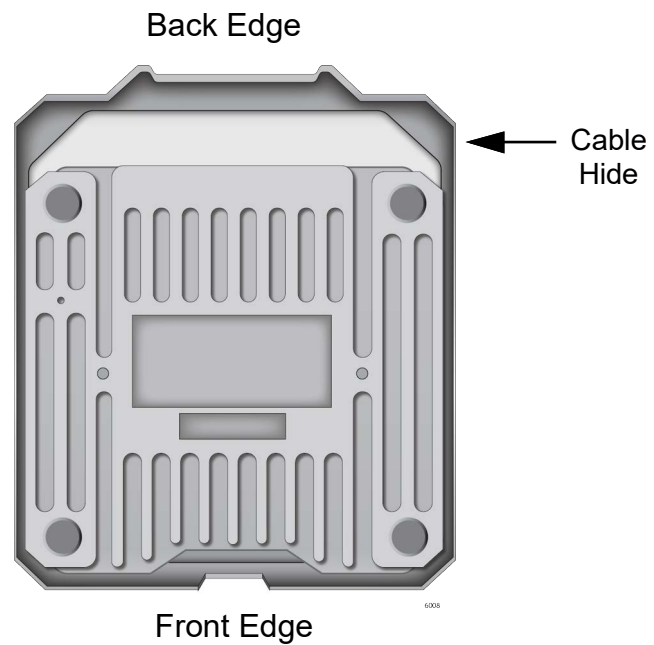

Figure 2. Access Point Bottom View

The front edge view is illustrated in Figure 3.

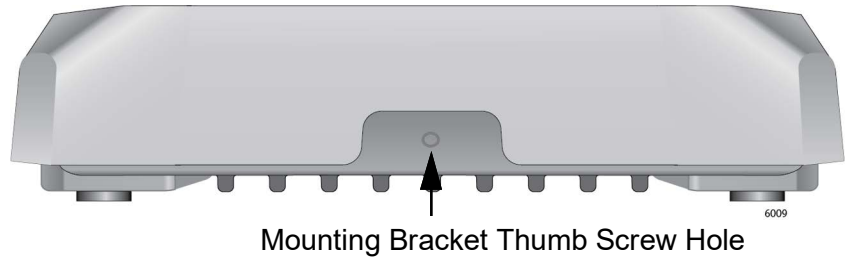

Figure 3. Front Edge View

The back edge view is illustrated in Figure 4.

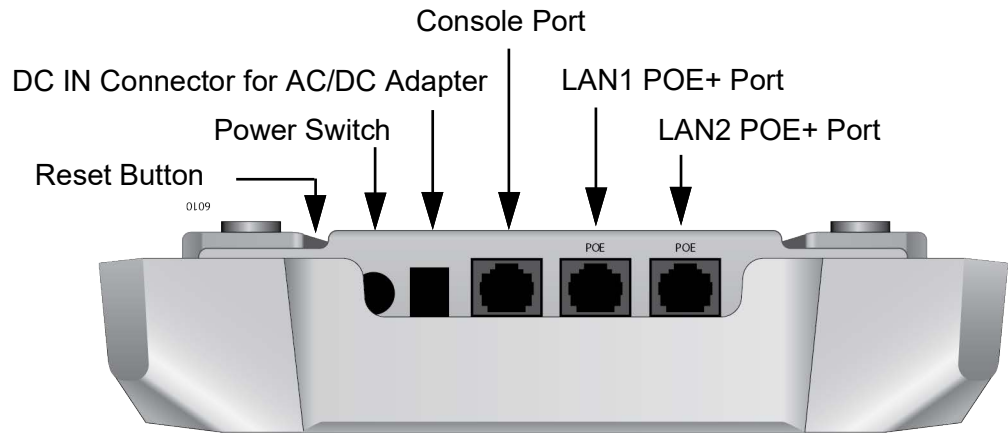

Figure 4. Back Edge View

The left edge view is illustrated in Figure 5.



Figure 5. Left Edge View

Cable Hide

The top cover of the access point is larger than the access point chassis to create space on the back for cable connectors and cables shown in Figure 2 on page 15.

Console Port

The Console Serial port on the back panel is for manufacturing purposes only.

Power Switch

The Power Switch on the back panel in Figure 4 on page 15 turns On or OFF the access point when power is supplied to the access point only from the AC adapter, not from PoE LAN ports.

When power is supplied to the access point from the PoE LAN ports, the state of the Power Switch does not affect the access point.

Kensington Lock Hole

The left panel has a hole for the Kensington lock to be connected to an anti-theft cable/lock to physically secure the access point as shown in Figure 5 on page 16.

Reset Button

The access point has a Reset button on the back edge in Figure 4 on page 15 for returning the parameter settings of the device to their default values. You might reset the access point if you want to discard its current configuration or if you forgot the manager password and so cannot manage the device.

To reset the device, press the button for five seconds and release.

You can enable or disable the reset button with the management software.

The default setting for the button is enabled. If the access point is installed in a public area, you probably should disable it to protect the device from being reset by unauthorized individuals.

LAN1 and LAN2 Ports

The wireless access point has two Ethernet ports, labeled LAN1 and LAN2. You use the ports to connect the wireless access point to your wired network. Here are their basic properties:

- ❑ LAN1 and LAN2 ports support PoE+.
- ❑ The default setting for LAN1 port is enabled. You cannot disable it.
- ❑ The default setting for LAN2 port is disabled.
- ❑ LAN1 and LAN2 ports can be combined into a static Link Aggregation (LAG) to double the bandwidth between the wireless access point and the wired network.
- ❑ LAN2 can be configured as a separate Ethernet port for another network device. This is referred to as the Cascade mode.

Static Link Aggregation

You can double the bandwidth between the wireless access point and your wired network by combining LAN1 and LAN2 ports into a static LAG. A static LAG functions as a single logical link between the wireless access point and another network device, such as an Ethernet switch or router. A static LAG also provides link redundancy. If one link goes down, the wireless access point maintains connectivity to the wired network over the remaining link. Refer to Figure 6.

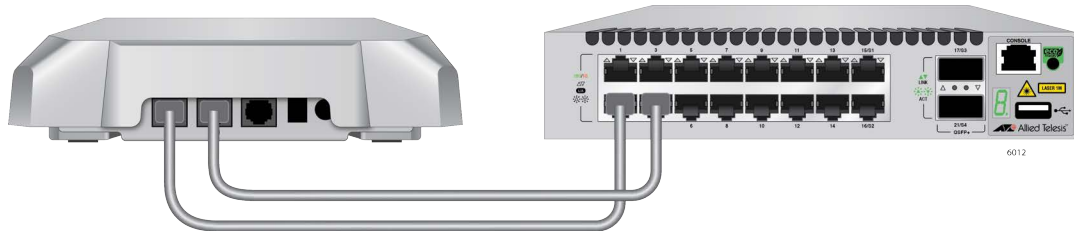

Figure 6. LAN1 and LAN2 Ports in a Static LAG

Here are guidelines to using LAN1 and LAN2 ports as a static LAG:

- ❑ You have to connect the ports to the same network device, such as an Ethernet switch or router, or virtual stacking devices. Do not connect the LAN ports to different network devices.
- ❑ The network device has to support static LAGs.
- ❑ You have to configure the two ports on the network device as a static LAG.
- ❑ You activate the static LAG for LAN1 and LAN2 ports with the on-board web browser management interface.

Note

Do not enable and cable the LAN2 port until after you have configured the other network device for the static LAG.

Cascade Mode The LAN2 port also has a Cascade mode. The mode allows you to use the port to connect another device to your network. The device can be an end node such as a printer or computer, as shown in Figure 7.

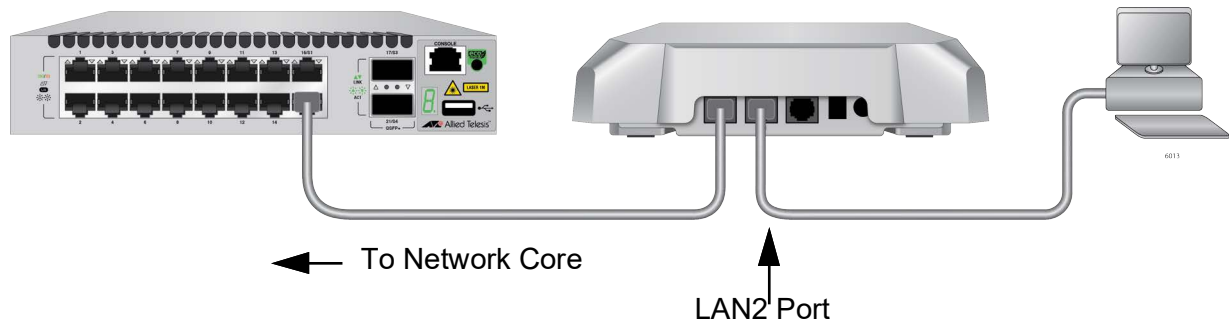

Figure 7. LAN2 Port in Cascade Mode with an End Node

It can also be a networking device such as a switch, router, or media converter. Refer to Figure 8.

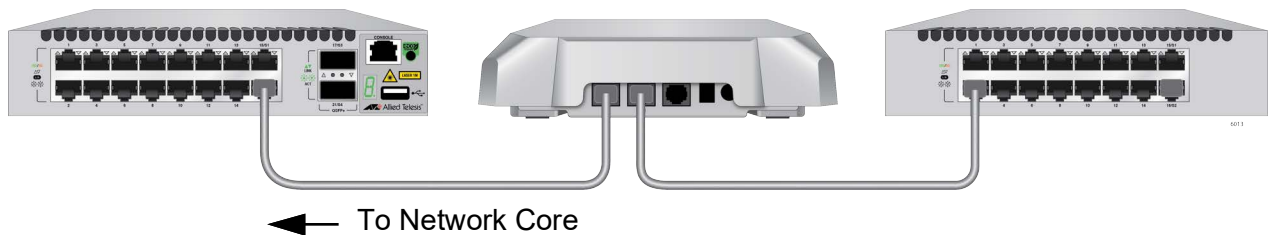

Figure 8. LAN2 Port in Cascade Mode with a Networking Device

Here are the Cascade mode guidelines:

- The Cascade mode requires firmware version 6.0.1-2.1 or later.
- You set the Cascade mode with the on-board web browser management interface.
- The Cascade mode is not supported with Vista Manager EX and the AWC plug-in.
- Do not connect both LAN1 and LAN2 ports to the same network device when the LAN2 port is in the Cascade mode.

Power Over Ethernet Plus (PoE+)

You can power the wireless access point with either PoE+ on the LAN1 port, LAN2 port or an AC/DC power adapter. The wireless access point is a PoE+ Class 4 powered devices, with maximum power consumption of 25.5 watts. To power the device with PoE+, you have to connect LAN1 or LAN2 port to PoE+ power sourcing equipment (PSE). The network cable connecting the LAN1 or LAN2 port to the PoE+ PSE carries both network traffic and PoE+.

You can power the device with both PoE+ and an AC/DC power adapter. However, the two power sources are not load sharing. The power adapter is the primary power source and PoE+ is redundant power.

Connector Type

The LAN ports have an eight-pin RJ45 connector. The port uses four pins of the connector at 100 Mbps and all eight pins at 1G/2.5G/5Gbps. Refer to the tables in “Port Pinouts” on page 52 for the pin assignments.

Speed

The LAN ports have speeds of 100Mbps/1G/2.5G/5Gbps. The speeds are set automatically with Auto-Negotiation. You cannot disable Auto-Negotiation on the ports.

Note

The LAN ports should be connected to network devices that also adjust port speeds with Auto-Negotiation. If a network device does not support Auto-Negotiation, the LAN ports operate at 100 Mbps, which may reduce network performance.

Duplex Mode

Both LAN ports can operate in either half- or full-duplex mode at 100Mbps, and full-duplex mode at 1G/2.5G/5Gbps. The ports are IEEE802.3u compliant and use Auto-Negotiation to set the duplex mode. You cannot disable Auto-Negotiation on the port.

Note

The network device to which you connect the LAN ports should also set the duplex mode with Auto-Negotiation. If a network device does not support Auto-Negotiation, the LAN port operates at half-duplex mode. This may result in a duplex mode mismatch if the network device is operating at full duplex.

Automatic MDIX Detection

When operating at 100Mbps, the twisted-pair ports feature automatic MDIX detection. (Automatic MDIX detection does not apply to 1G/2.5G/5Gbps.) This feature automatically configures the ports to MDI or MDI-X depending on the wiring configuration of the port on the Ethernet switch.

You cannot disable automatic MDIX detection. For automatic MDIX detection to work properly, this feature must also be present on the Ethernet switch. The LAN port defaults to MDIX if it is connected to a network device that does not support automatic MDIX detection.

Cable Requirements

The minimum cable requirements for the ports are listed here.

- ❑ 100 Mbps port: Standard TIA/EIA 568-B-compliant Category 3 shielded or unshielded cabling.
- ❑ 1/2.5/5Gbps port: Standard TIA/EIA 568-A-compliant Category 5 or TIA/EIA 568-B-compliant Enhanced Category 5 (Cat 5e) unshielded cabling.

Maximum Distance

The LAN ports have a maximum operating distance of 100 meters (328 feet).

Port Pinouts

See Table 7 on page 52 for port pinouts information.

Guidelines

Here are the guidelines to using the LAN1 and LAN2 ports:

- ❑ If you are connecting only one LAN port to your network, you have to use port LAN1.
- ❑ The default setting for the LAN1 port is enabled. You cannot disable it.
- ❑ The default setting for LAN2 is disabled. To activate it, use the on-board web browser management interface.
- ❑ To use the LAN1 and LAN2 ports as a static LAG, you have to connect them to the same network device, such as an Ethernet switch or router, or virtual stacking devices. Do not connect the LAN ports to different network devices. The network device has to support static LAGs.



Caution

When using LAN1 and LAN2 ports as a static LAG, do not activate the LAN2 port until you have configured the ports on the network device to which the LAN ports are connected as a static LAG. Refer to the documentation for the network device for instructions.

- ❑ To activate the Cascade mode for LAN2, use the on-board web browser management interface.

AC Adapter for External Power Supply

The access point can be powered in two ways:

- ❑ PoE+ Sourcing Equipment (PSE) on LAN1 and/or LAN2 ports
- ❑ AC power adapter

You can also power it with both methods for power redundancy. The power sources are not load-sharing. A wireless access point that has both power sources uses the AC power adapter as its primary power source and PoE+ as redundant power.

For technical specifications, refer to “Power Specifications” on page 50. The PWRADP-01 (DA-48Z12) Power Adapter, shown in Figure 9, from Allied Telesis is approved for this product.



Figure 9. PWRADP-01 (DA-48Z12) Power Adapter

LEDs

The LEDs on the top panel display status information. See Figure 10 for LEDs and Table 1 for the status definition.



Figure 10. TQ6602 GEN2 and TQm6602 GEN2 Access Points' LEDs

Table 1. LED Status Information

LED	State	Description
PWR/ SYS	Green	The access point is powered ON and operating normally.
	Blinking Green	The access point is booting up.
	Red	The access point has encountered a fault condition.
	Blinking Red	The access point is upgrading its firmware.
	Off	The access point is <i>not</i> receiving power.
LAN1	Green	The port has established a link to a network device.
	Blinking Green	The port is transmitting or receiving data.
	Amber	The port is connected to PoE+ power sourcing equipment.
	Off	The port has not established a link to a network device.

Table 1. LED Status Information (Continued)

LED	State	Description
LAN2	Green	The port has established a link to a network device.
	Blinking Green	The port is transmitting and receiving data.
	Amber	The port is connected to PoE+ power sourcing equipment.
	Off	The port has not established a link to a network device.
2.4GHz	Green	The 2.4GHz radio is enabled.
	Off	The 2.4GHz radio is disabled.
5 GHz	Green	The 5GHz radio is enabled.
	Off	The 5GHz radio is disabled.

Chapter 2

Installing the Wireless Access Point

This chapter contains the installation procedures for the TQ6602 GEN2 Access Points. The procedures are detailed in the following sections:

- ❑ “Reviewing Safety Precautions” on page 26
- ❑ “Unpacking the Shipping Box” on page 29
- ❑ “Reviewing Installation Guidelines” on page 30
- ❑ “Installing the Access Point on a Table” on page 32
- ❑ “Overview to Installing the Access Point on a Wall or Ceiling” on page 33
- ❑ “Pre-fitting the Mounting Bracket on the Access Point” on page 34
- ❑ “Installing the Mounting Bracket on a Wall or Ceiling” on page 36
- ❑ “Connecting Ethernet Cables to LAN1 and LAN2 Ports” on page 40
- ❑ “Connecting the AC Power Adapter” on page 42
- ❑ “Attaching the Access Point to the Mounting Bracket” on page 43
- ❑ “Installing an Anti-theft Device” on page 46
- ❑ “Starting the First Management Session” on page 47

Note

The non-US models of this product have a country code setting that must be set during the initial management session of the units. The setting ensures that the units operate in compliance with the laws and regulations of your country or region.

For the US model, the country code is preset and cannot be changed. Per FCC regulations, the country code setting for all WiFi products marketed in the US must be fixed to US operational channels only.

Reviewing Safety Precautions

Please review the following safety precautions before installing the access point.

Important: Safety statements that have the  symbol are translated into multiple languages in the *Translated Safety Statements* document, which is available at www.alliedtelesis.com/library.



Warning

To prevent electric shock, do not remove the cover. No user-serviceable parts inside. This unit contains hazardous voltages and should only be opened by a trained and qualified technician. To avoid the possibility of electric shock, disconnect electric power to the product before connecting or disconnecting the LAN cables.

 **E1**



Warning

Do not work on equipment or cables during periods of lightning activity.  **E2**



Warning

All Countries: Install product in accordance with local and National Electrical Codes.  **E8**



Warning

Only trained and qualified personnel are allowed to install or to replace this equipment.  **E14**



Warning

To reduce the risk of electric shock, the PoE ports on this product must not connect to cabling that is routed outside the building where this device is located.  **E40**



Warning

This equipment shall be installed in a Restricted Access location.

 **E45**

**Warning**

FCC Caution: Any changes or modifications not expressly approved by the party responsible for compliance could void the user's authority to operate this equipment. ⚡ E80

Note

The access point must be powered by:

1. A UL listed external AC/DC power supply suitable for use at Tma 50 °C, a maximum operating altitude of 3000 m or higher, and whose output meets separated extra-low voltage (SELV), limited power sources (LPSs) and is rated 12 VDC, 4.0 A,

OR

2. By Power over Ethernet through a UL listed ITE. Refer to Table 4, "External AC/DC Adapter Specifications" on page 50.

**Caution**

Air vents must not be blocked and must have free access to the room ambient air for cooling. ⚡ E6

**Warning**

An operational unit can be hot. Exercise caution when handling with unprotected hands.

**Warning**

Operating Temperature. This product is designed for a maximum ambient temperature of 50°C (122° F) ⚡ E7.

**Warning**

To reduce the risk of electric shock, the PoE port on this product must not connect to cabling that is routed outside the building where this device is located. ⚡ E40

**Warning**

This equipment is intended for indoor use only. ⚡ E95

Note

If you are not using PoE to power to unit, use only an approved AC/DC adapter. Refer to “Power Specifications” on page 50.



Caution

The unit does not contain serviceable components. Please return damaged units for servicing.  E42

Note

You should verify that your PoE network adheres to the standards of a separated extra-low voltage (SELV) circuit before using the PoE feature on the wireless access point.

Unpacking the Shipping Box

To verify the contents of the shipping box, perform the following procedure:



1. Remove all components from the shipping box.

Note

Store the packaging material in a safe location. Please use the original shipping material if you need to return the device to Allied Telesis.

2. Verify the contents of the shipping box listed in Table 11. If any item is missing or damaged, contact your Allied Telesis sales representative for assistance.

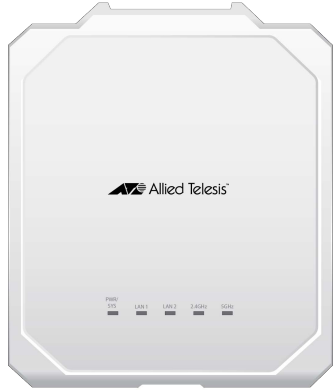
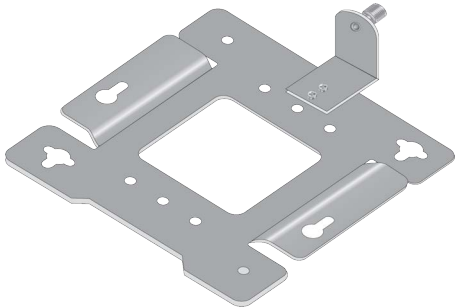
Figure 11. Shipping Box Components

Name	Component
One TQ6602 GEN2 Access Point	
One Mounting Bracket	
Two M5 x 4.5 mm, Pan-head Screws	

Reviewing Installation Guidelines

Review the following guidelines before installing the access point:

- ❑ The ceiling or wall mounting surface must be of proper material to accommodate the screws and strong enough to support the weight of the access point and cables. (Refer to Table 2 on page 49 for the product weight.)
- ❑ You can install the access point on a wall where Cisco or Fortinet bracket has already been installed. You need a bracket converter. See “the *BRKT-CONV-AP1 Bracket Converter Installation Guide*” for more information.
- ❑ Connect the Ethernet cable(s) and power cord (if applicable) to the access point before installing the product on the ceiling or wall. Depending on the installation location, connecting or removing cables may be difficult after the device is installed.
- ❑ Verify that the Ethernet cable(s) is long enough to connect to its destination port(s) before installing the access point. Once the installation is complete, it is physically difficult to change the cables.
- ❑ If the wireless access point is powered by an AC adapter, verify that an AC power outlet is within six feet of the planned installation site. (Refer to “Power Specifications” on page 50 for the AC adapter specifications.)
- ❑ Refer to Figure 12 on page 31 for approved orientations of the wireless access point on a table, wall, or ceiling.

Ceiling Installation

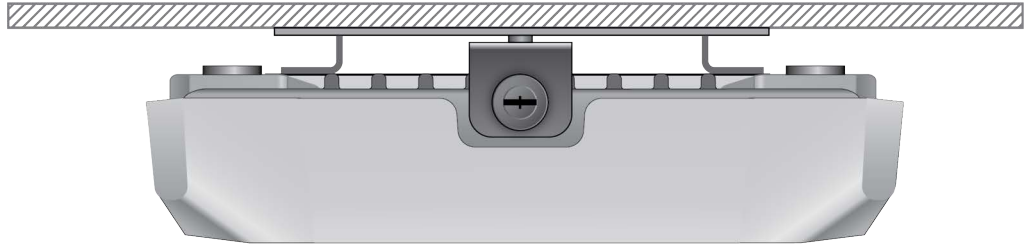

Wall Installation

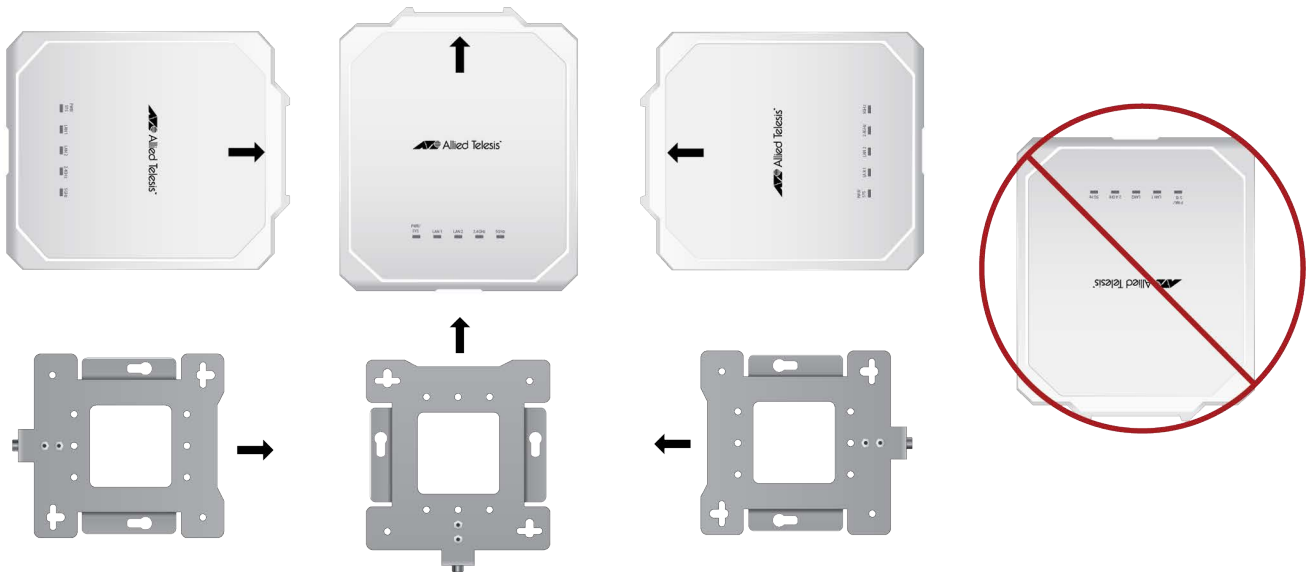
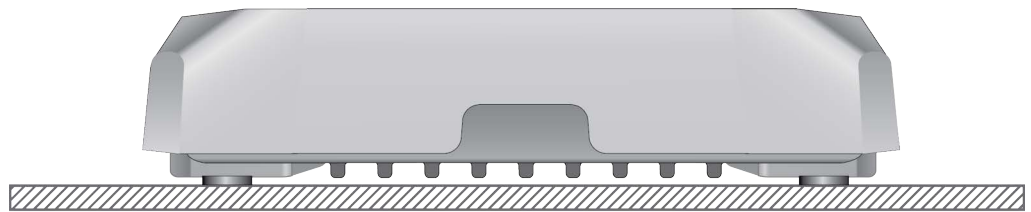

Table Installation



6017

Figure 12. Approved Installation Orientations on a Ceiling, Wall, or Table

Installing the Access Point on a Table

You need the following items to install the access point on a table:

- TQ6602 GEN2 or TQm6602 GEN2 Access Point
- One or two Ethernet cables
- External AC power adapter (Optional if using PoE+. Required if not using PoE+ or for redundant power.)
- Kensington lock (optional)

Note

See “Reviewing Safety Precautions” on page 26 and “Reviewing Installation Guidelines” on page 30 before installing the product.

Perform the following steps to install the wireless access point on a table:

1. Place the access point at the selected location on the table.
2. Connect Ethernet cables to LAN1 and LAN2 ports. Refer to “Connecting Ethernet Cables to LAN1 and LAN2 Ports” on page 40.
3. To connect an AC power adapter to the access point, go to “Connecting the AC Power Adapter” on page 42.
4. To install a security cable, refer to “Installing an Anti-theft Device” on page 46.
5. To start managing the device, go to “Starting the First Management Session” on page 47.

Overview to Installing the Access Point on a Wall or Ceiling

Here are the procedures for installing the wireless access point on a wall or ceiling:

- ❑ “Pre-fitting the Mounting Bracket on the Access Point” on page 34
- ❑ “Installing the Mounting Bracket on a Wall or Ceiling” on page 36
- ❑ “Connecting Ethernet Cables to LAN1 and LAN2 Ports” on page 40
- ❑ “Connecting the AC Power Adapter” on page 42
- ❑ “Attaching the Access Point to the Mounting Bracket” on page 43
- ❑ “Installing an Anti-theft Device” on page 46

Note

Please see “Reviewing Safety Precautions” on page 26 and “Reviewing Installation Guidelines” on page 30 before installing the product.

Note

Depending on the installation location, it may be easier to connect the network cables and optional power adapter to the wireless access point before installing it on the wall or ceiling.

You need the following items to install the wireless access point on a ceiling or wall:

- ❑ TQ6602 GEN2 or TQm6602 GEN2 Access Point
- ❑ Two screws to attach the access point to the mounting bracket
- ❑ Mounting bracket
- ❑ Four (4) M4, 25.0 mm flat-head wood screws and anchors (not provided) for fastening the mounting bracket
- ❑ Phillips head screwdriver (not provided)
- ❑ Pencil (not provided)
- ❑ External AC power adapter (Optional if using PoE+. Required if not using PoE+ or for redundant power.)
- ❑ Kensington lock (optional and not provided)

Note

The four Phillips head M4 screws/anchors, the Phillips head screwdriver, pencil, external AC power adapter and Kensington lock are *not* included with the product.

Pre-fitting the Mounting Bracket on the Access Point

To pre-fit the mounting bracket on the access point, perform the following procedure:

1. Place the wireless access point upside down on a table.
2. Install the two screws (provided) fully into the bottom panel of the access point. See Figure 13.

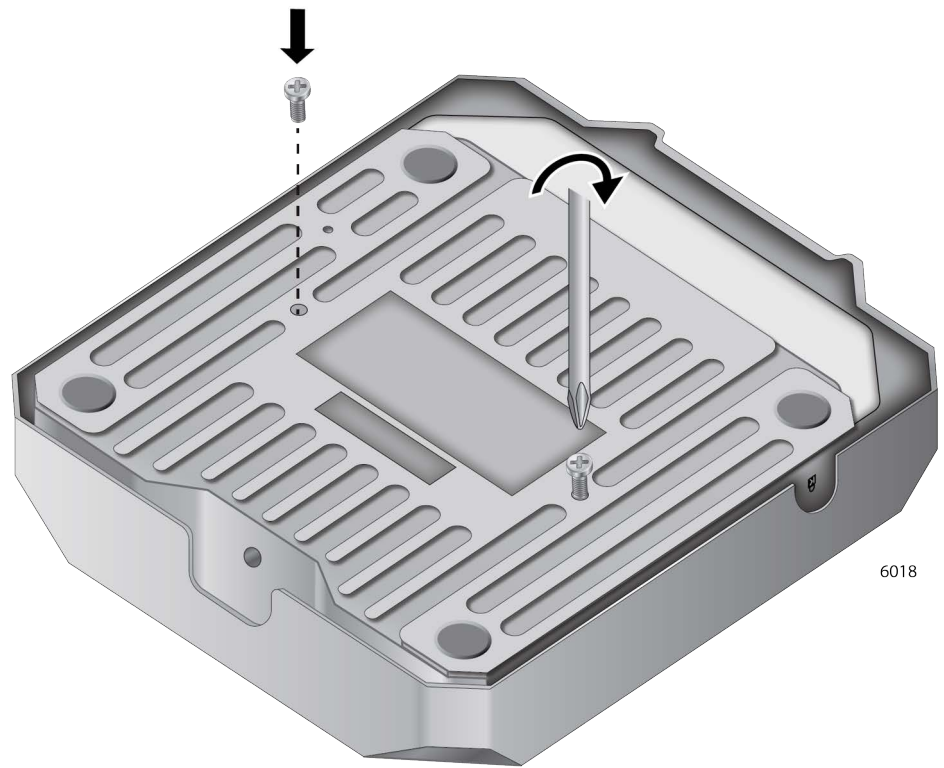

Figure 13. Attaching the Bracket Screws to the Access Point

The screw collar provides the proper spacing for the mounting bracket beneath the screw head. See Figure 14.



Figure 14. Panel Screw

3. Make sure that the mounting bracket fits to the access point by sliding the bracket beneath the screws as shown in Figure 15.



Figure 15. Attaching the Mounting Bracket on the Access Point

4. Slide the mounting bracket forward and remove it from the access point. See Figure 16.

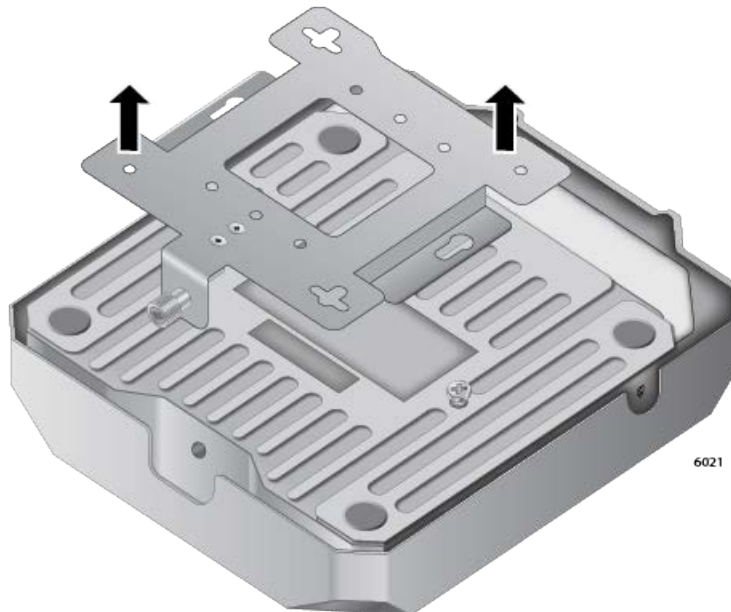

Figure 16. Removing the Mounting Bracket from the Access Point

5. Go to “Installing the Mounting Bracket on a Wall or Ceiling” on page 36.

Installing the Mounting Bracket on a Wall or Ceiling

To install the mounting bracket on a wall or ceiling, perform the following procedure:

1. Choose the location and orientation for the access point on the wall or ceiling. Refer to Figure 12 on page 31.
2. Position the mounting bracket at the selected location and orientation for the access point. Consider the following guidelines.
 - ❑ The thumbscrew on the mounting bracket is where the front panel of the access point will be.
 - ❑ The ports and connectors are on the back panel, away from the thumbscrew.
3. With a pencil, mark the wall or ceiling with the two key-hole slots of the bracket. Refer to Figure 17.

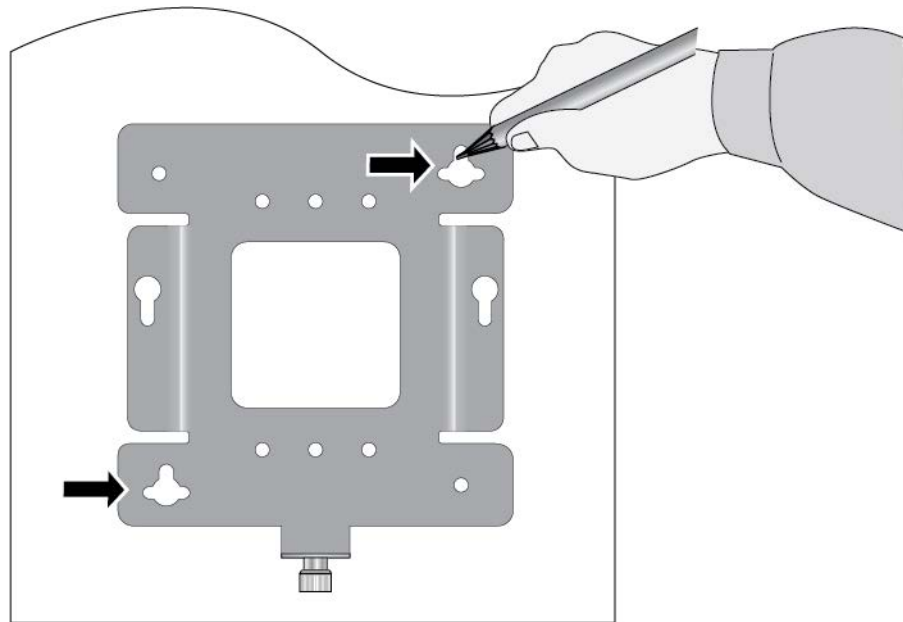

Figure 17. Marking the Holes for the Key-Hole Slots

4. Pre-drill the two marked locations for the keyhole slots on the hard-surface ceiling or wall.

5. Install two M4 screws and anchors (if required). Leave the screws loose enough so that the bracket can slide under the screw heads. Refer to Figure 18.

Note

For a wooden wall or ceiling, use M4 x 25 mm flat-head wood screws and anchors, if required. The screws and anchors are not provided.

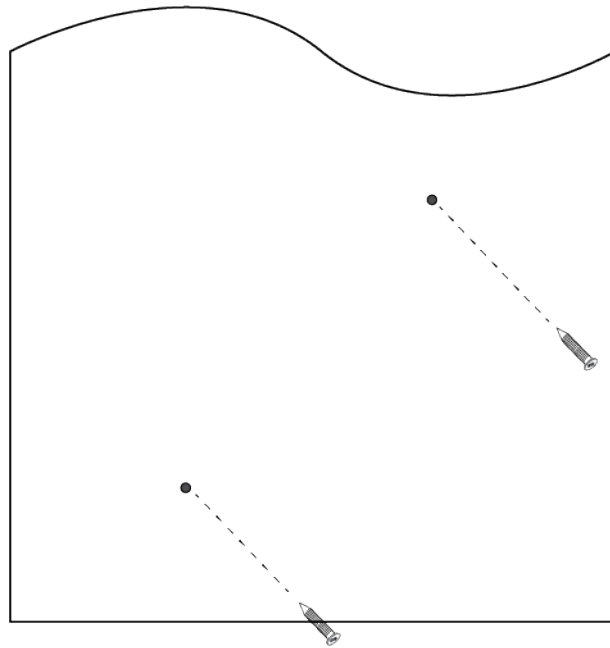

Figure 18. Installing Two Screws

6. Insert the openings of the bracket key-hole slots under the two screw heads and slide the bracket into the narrow end of the key-hole slot openings. See Figure 19.

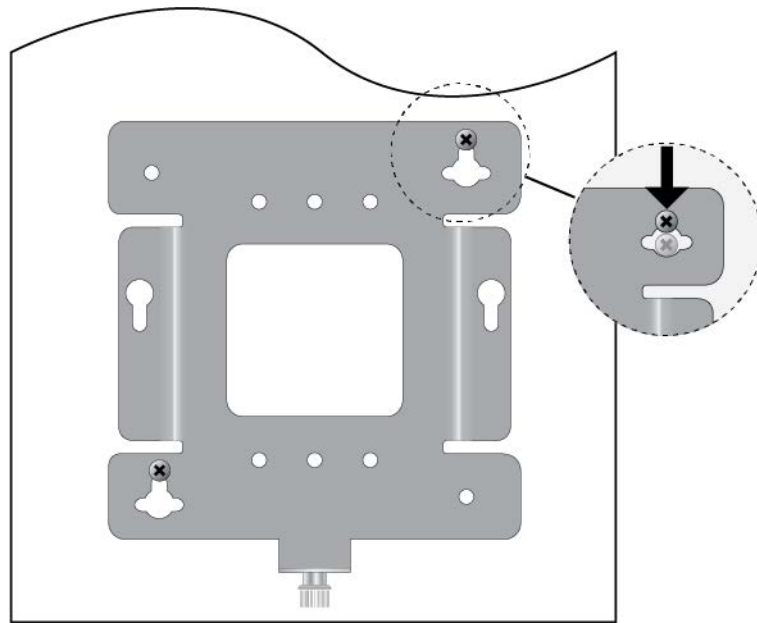

Figure 19. Installing the Mount Bracket On the Screws

7. Tighten the screws snugly onto the bracket.
8. To secure the mounting bracket, pre-drill holes through the two bracket mounting holes opposite the key-hole slots. See Figure 20.

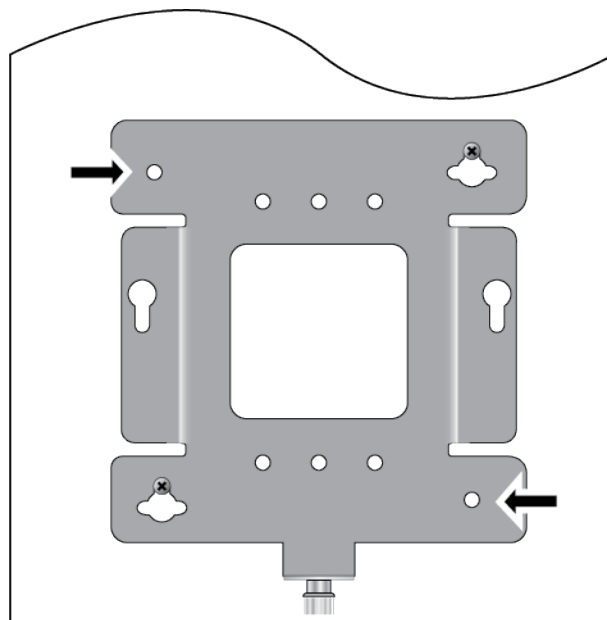

Figure 20. Pre-Drill Holes on Mounting Bracket

9. Install and tighten two M4 screws (not provided) in the holes prepared in Step 8.

The bracket installation is now complete. See Figure 21.

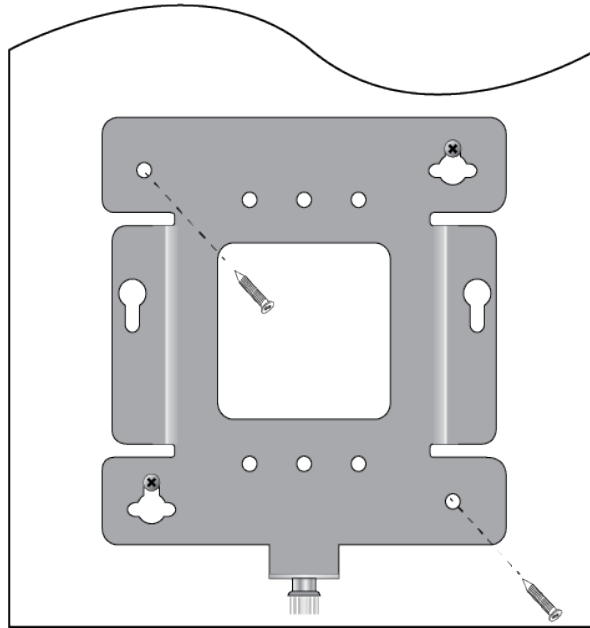

Figure 21. Securing the Mount Bracket

10. Go to “Connecting Ethernet Cables to LAN1 and LAN2 Ports” on page 40.

Connecting Ethernet Cables to LAN1 and LAN2 Ports

This section describes the instructions for connecting Ethernet cables to the LAN1 and LAN2 ports.

Guidelines

Review the following guidelines before connecting cables to the LAN1 and LAN2 ports:

- ❑ For information on cable specifications, see “Cable Requirements” on page 21.
- ❑ If you are installing the access point on a ceiling or wall, you might find it easier to connect the cables before placing the unit on the mounting bracket.
- ❑ You must use port LAN1 if you are connecting only one LAN port to the network.
- ❑ To power the access point through PoE+ LAN port(s), see “PoE+ Power Requirements” on page 50.
- ❑ To use both LAN1 and LAN2 ports, you have to connect them to the same network device. The device must support static LAGs.
- ❑ The default setting for the LAN2 port and static LAG on the wireless access point is disabled. You enable them with the on-board web browser management interface. For instructions, see the *TQ6000 GEN2 Management Software User’s Guide*.

Note

Do not enable the LAN2 port until you have configured the other network device for the static LAG.

Connecting the Ethernet Cables to LAN Ports

To connect the network cables, perform the following procedure:

1. To cable LAN1 port, connect an Ethernet cable into the port. The cable requirements are in “Cable Requirements” on page 21. Refer to Figure 22.

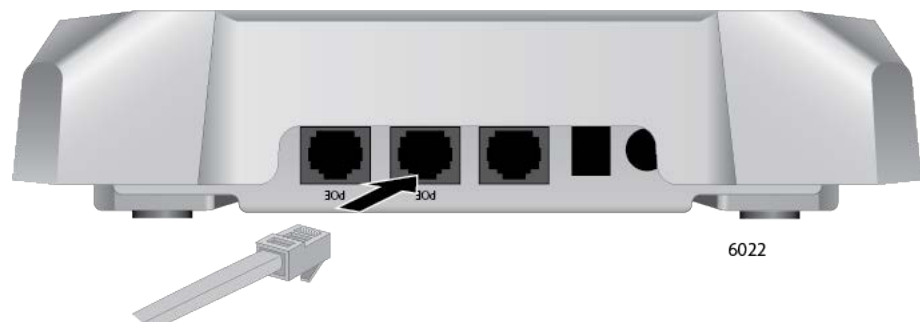

Figure 22. Connecting an Ethernet Cable to the LAN1 Port

2. Connect the other end of the Ethernet cable to a network Ethernet device, such as an Ethernet switch or router.

Note

If the device is PoE+ power sourcing equipment (PSE), the access point begins to power on and initialize its management software.

3. To use LAN2 port in the static LAG or Cascade mode, connect a second Ethernet cable to the port. See Figure 23.

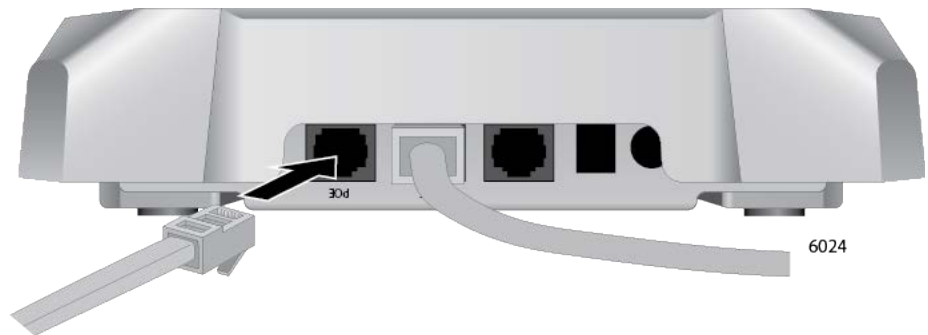

Figure 23. Connecting the Ethernet Cable to the LAN2 Port

4. Connect the other end to a network device. To use the port as a static LAG with the LAN1 port, connect it to the same router or switch as LAN1 port. To use it in the Cascade mode, connect it to a different device. For an overview, refer to “Static Link Aggregation” on page 18 and “Cascade Mode” on page 19.

Note

The default setting for the LAN2 port is disabled. To set it to the Static LAG or Cascade mode, use the on-board web browser management interface, explained in the *TQ6000 GEN2 Management Software User Guide*.

5. Do one of the following:
 - a. If the access point is to be power only by PoE+, without an AC power adapter, go to “Attaching the Access Point to the Mounting Bracket” on page 43.
 - b. To connect an external AC power adapter, go to “Connecting the AC Power Adapter”.

Connecting the AC Power Adapter

The access point can be powered with PoE+ on the LAN1 or/and LAN2 ports, an AC power adapter, or both. A wireless access point that is powered by both methods uses the AC adapter as its primary power and PoE as redundant power. For an AC power adapter, Allied Telesis recommends the PWRADP-01 (DA-48Z12) Power Adapter.

If you purchased a power adapter for the wireless access point, perform the following procedure. Otherwise, go to “Attaching the Access Point to the Mounting Bracket” on page 43.

Perform the following procedure to install an AC power adapter:

1. If the AC power adapter has replaceable AC plugs, verify that the current plug on the adapter is the correct plug for your region. If it is not, install the correct AC plug by following the instructions provided with the adapter.
2. Plug the DC connector of the power adapter into the DC IN jack on the access point. Refer to Figure 24.

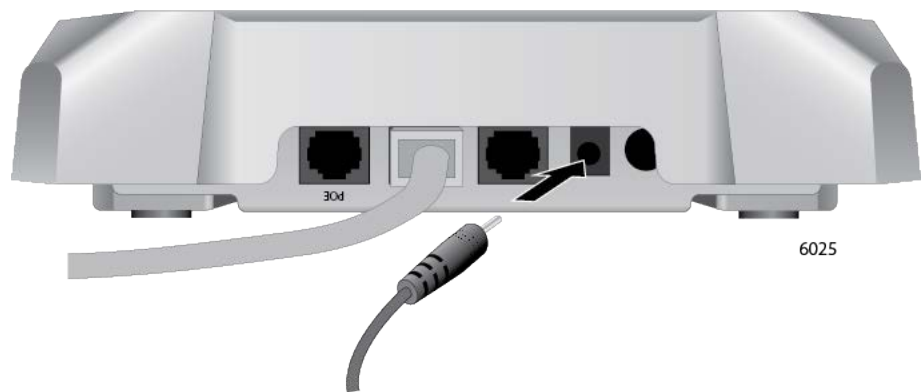

Figure 24. Connecting an AC Power Adapter to the Access Point

3. Connect the power adapter into an appropriate AC power source.
4. Turn on the Power Switch.

Note

The Power Switch controls power from the AC power supply. It does not control PoE+ on the LAN1 and LAN2 ports.

5. Go to “Attaching the Access Point to the Mounting Bracket” on page 43.

Attaching the Access Point to the Mounting Bracket

To attach the wireless access point on the mounting bracket on the wall or ceiling, perform the following procedure:

1. Align the bottom of the access point over the bracket so that the two screws on the bottom of the device fit into the bracket keyholes. Refer to Figure 25. (These are the two access point chassis screws installed in “Pre-fitting the Mounting Bracket on the Access Point” on page 34.)

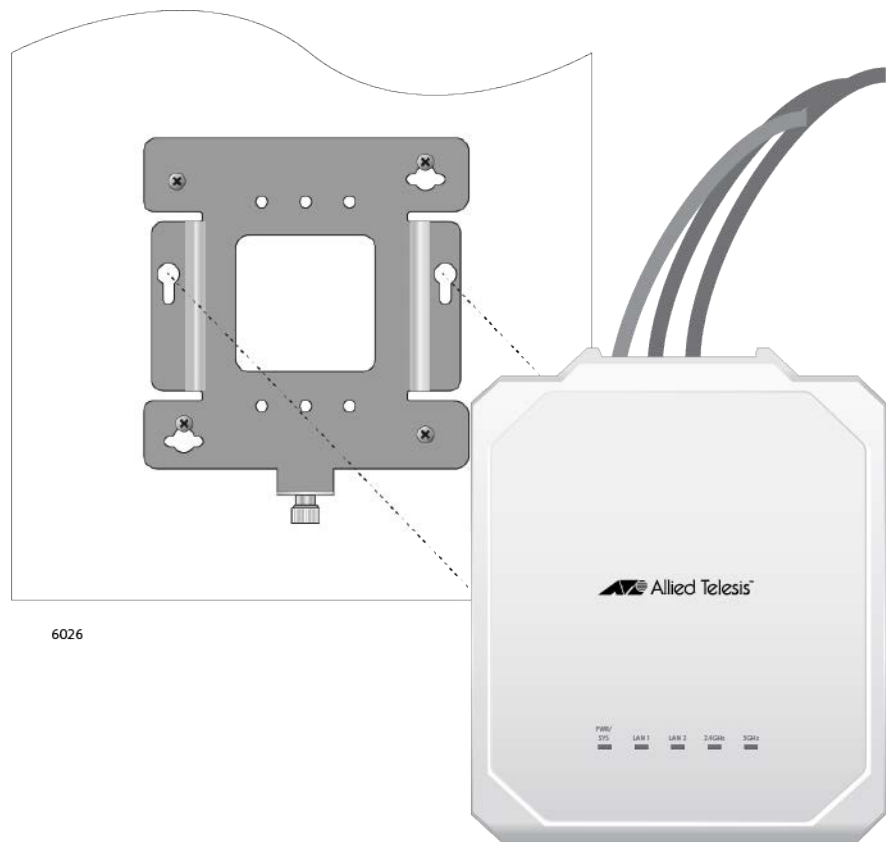

Figure 25. Installing the Access Point on the Mounting Bracket

2. Slide the access point forward until its screws are seated in the bracket keyhole slots and the bracket thumbscrew is aligned with the screw hole on the front panel.

See Figure 26 on page 44 for the access point and bracket orientations.

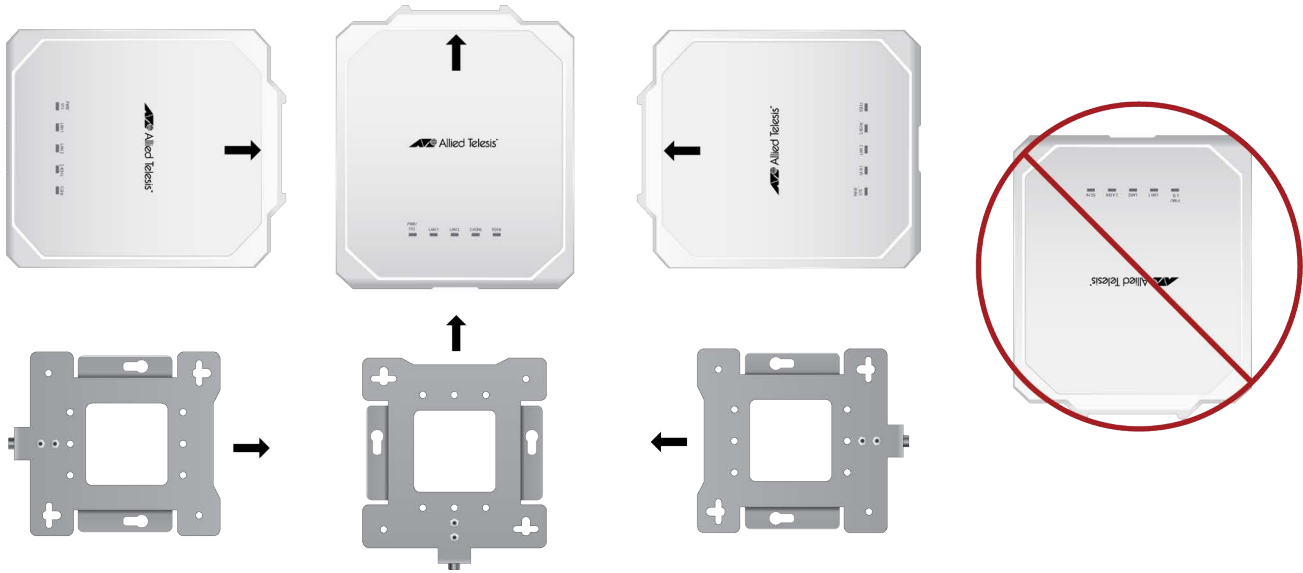

Figure 26. Seating the Access Point on the Mounting Bracket

3. Tighten the thumbscrew to secure the access point to the mounting bracket. Refer to Figure 27.

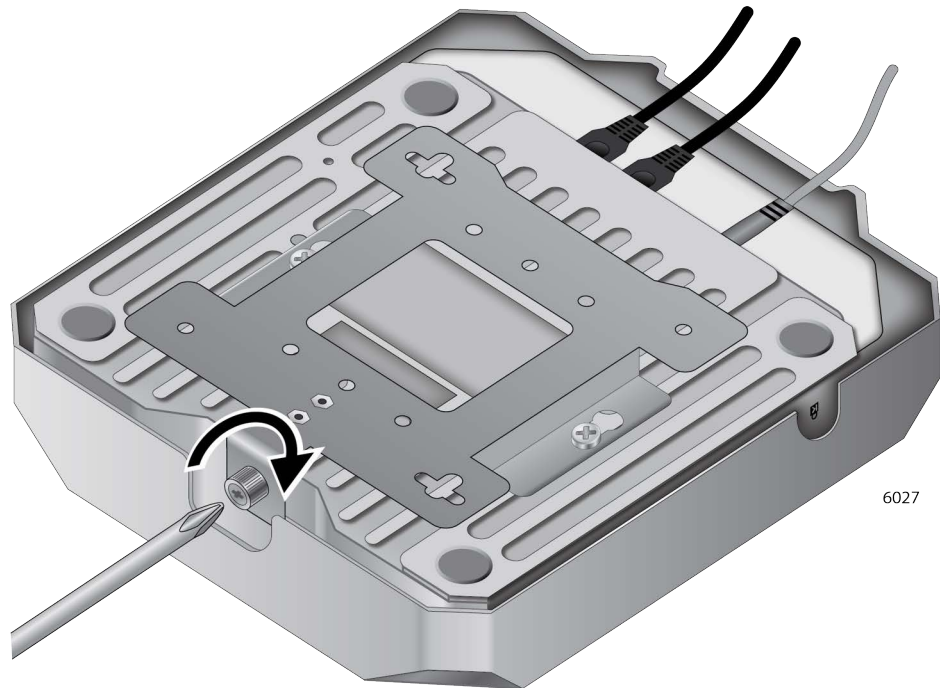

Figure 27. Tightening the Mounting Bracket Thumbscrew

4. Place the Ethernet cable(s) and power cable (if any) along the cable guides inside of the top cover in the cable hide space. See Figure 28.

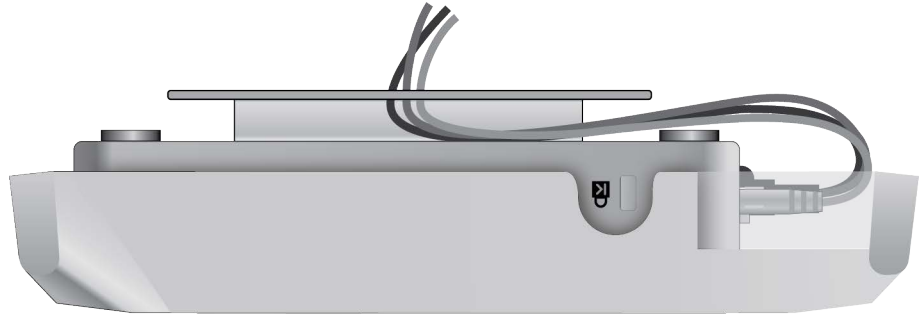

Figure 28. Fitting the Cables in the Cable Hide

5. Go to “Installing an Anti-theft Device” on page 46 or “Starting the First Management Session” on page 47.

Installing an Anti-theft Device

Installation of an anti-theft cable/lock is optional. The access point has a lock port that is compatible with a Kensington lock. The lock port can be used to physically secure the device to a table, wall, or a ceiling.

Note

Anti-theft devices are not available from Allied Telesis.

1. Follow the instructions provided with the vendor's anti-theft device for the installation. See Figure 29 for the Kensington lock port location.

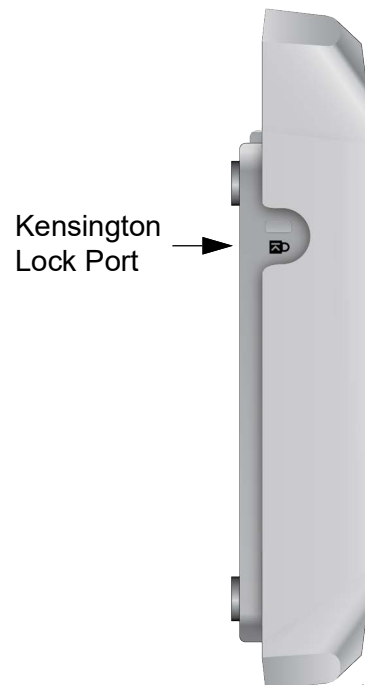

Figure 29. Kensington Lock Port Location

2. If you are installing the wireless access point on a wall or ceiling and have not installed in on the mounting bracket yet, go to “Attaching the Access Point to the Mounting Bracket” on page 43.

Starting the First Management Session

This section contains an abbreviated version of the procedure to start the first management session. For complete instructions, refer to the *TQ6000 GEN2 Management Software User's Guide*.

The wireless access point firmware includes a DHCP client. The default setting for the client is enabled. When you power on the access point for the first time, it queries the subnet on the LAN1 port for a DHCP server. If a DHCP server responds to its query, the unit uses the IP address the server assigns to it. If there is no DHCP server, the access point uses the default IP address 192.168.1.230.

To start the first management session, perform the following procedure:

1. Start the web browser on your management workstation.
2. Enter the IP address of the wireless access point in the URL field of the web browser. The address is one of the following:
 - If your network does not have a DHCP server, enter the default address 192.168.1.230.
 - If your network has a DHCP server, enter the IP address the DHCP server assigned to the access point.

The wireless access point displays the login prompt. Refer to Figure 30.

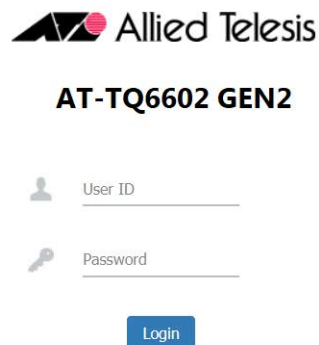

Figure 30. Login Prompt

3. Enter "manager" for the user name and "friend" for the password. The user name and password are case-sensitive.

Appendix A

Technical Specifications

This appendix contains the specifications for the TQ6602 GEN2 Access Points in the following sections:

- ❑ “Physical Specifications”
- ❑ “Environmental Specifications”
- ❑ “Power Specifications” on page 50
- ❑ “Cable Specifications” on page 51
- ❑ “LAN Ports Specifications and Pinouts” on page 52

Physical Specifications

Table 2. Physical Specifications

Parameter	Specification
Dimensions (W x D x H)	200 mm X 240 mm X 45 mm (7.9 in. x 9.4 in. x 1.8 in.)
Weight without mounting bracket	1.2 Kg (2.6 lbs)
Weight with mounting bracket	1.4 Kg (3.1 lbs)

Environmental Specifications

Table 3. Environmental Specifications

Parameter	Specification
Operating Temperature	0° C to 50° C (32° F to 122° F)
Storage Temperature	- 25° C to 70° C (- 13° F to 158° F)
Operating Humidity	0% to 90% non-condensing
Storage Humidity	0% to 95% non-condensing
Maximum Operating Altitude	3000 m (9843 ft)

Power Specifications

External AC Adapter Specifications

Table 4 lists the power requirements for an external AC/DC adapter.

Table 4. External AC/DC Adapter Specifications

Parameter	Specification
Input Voltage Range	100~240 VAC
Input Frequency	50 - 60 Hz
Rated Output Voltage	+12 VDC
Rated Output Current	4 A
Temperature Range	0° C to 50° C (32° F to 122° F)
Maximum Operating Altitude	3000 m (9843 ft)

Note

If you decide to use an AC adapter with the access point, Allied Telesis recommends the PWRADP-01 (DA-48Z12) adapter. The adapter is a UL Listed power supply and is compatible with the above specifications while meeting the standards of a separated extra-low voltage (SELV) product.

Note

The PWRADP-01 (DA-48Z12) adapter is sold separately.

PoE+ Power Requirements

Table 5 lists the PoE+ specifications for the PoE LAN ports.

Table 5. PoE+ Power Specifications on LAN Ports

Maximum Power Consumption	25.5 watts
Rated Voltage	DC 48V
Rated Current	0.67A

Note

Allied Telesis recommends using UL-certified PoE injectors.

Cable Specifications

The minimum cable requirements for ports LAN1 and LAN2 are listed here.

- ❑ 100Mbps ports: Standard TIA/EIA 568-B-compliant Category 3 shielded or unshielded cabling.
- ❑ 1G/2.5G/5G ports: Standard TIA/EIA 568-A-compliant Category 5 or TIA/EIA 568-B-compliant Enhanced Category 5 (Cat 5e) unshielded cabling.

Note

The maximum operating distance of the cables is 100 meters (328 feet).

LAN Ports Specifications and Pinouts

Port Specifications

The access point port specifications are shown in Table 6.

Table 6. LAN Port Specifications

Connector	Specification
PoE standard - LAN1 and LAN2	IEEE 802.3at (class 4)

Port Pinouts

The pin signal definitions for ports LAN1 and LAN2 are given here. Figure 31 illustrates the pin layout of the ports.

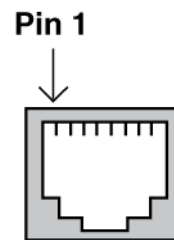

Figure 31. Pin Layout for RJ45 Connector on LAN Port

Table 7 lists the pin signals.

Table 7. Pin Signals for 100M/1G/2.5G/5G Base-T Connectors

Pin	100 Mbps MDI Signal	100 Mbps MDI-X Signal	1G/2.5G/5G Signal
1	TX+	RX+	Bi-directional pair A+
2	TX-	RX-	Bi-directional pair A-
3	RX+	TX+	Bi-directional pair B+
4	Not used	Not used	Bi-directional pair C+
5	Not used	Not used	Bi-directional pair C-
6	RX-	TX-	Bi-directional pair B-
7	Not used	Not used	Bi-directional pair D+
8	Not used	Not used	Bi-directional pair D-

Appendix B

Regulatory Statements

This appendix contains the following regulatory statements:

- ❑ “Federal Communication Commission Interference Statement” on page 54
- ❑ “European Union Restriction of the Use of Certain Hazardous Substances (RoHS) in Electrical and Electronic Equipment” on page 56
- ❑ “Industry Canada Statement” on page 57
- ❑ “UK - UKCA Declaration of Conformity” on page 59

Federal Communication Commission Interference Statement

This device complies with Part 15 of the FCC Rules. Operation is subject to the following two conditions: (1) This device may not cause harmful interference, and (2) this device must accept any interference received, including interference that may cause undesired operation.

This equipment has been tested and found to comply with the limits for a Class B digital device, pursuant to Part 15 of the FCC Rules. These limits are designed to provide reasonable protection against harmful interference in a residential installation. This equipment generates, uses and can radiate radio frequency energy and, if not installed and used in accordance with the instructions, may cause harmful interference to radio communications. However, there is no guarantee that interference will not occur in a particular installation. If this equipment does cause harmful interference to radio or television reception, which can be determined by turning the equipment off and on, the user is encouraged to try to correct the interference by one of the following measures:

- Reorient or relocate the receiving antenna.
- Increase the separation between the equipment and receiver.
- Connect the equipment into an outlet on a circuit different from that to which the receiver is connected.
- Consult the dealer or an experienced radio/TV technician for help.



Caution

FCC Caution: Any changes or modifications not expressly approved by the party responsible for compliance could void the user's authority to operate this equipment. Ⓜ E80



Caution

Avertissement de la FCC: Les changements ou modifications non expressément approuvés par la partie responsable de la conformité pourraient annuler l'autorité de l'utilisateur à utiliser cet équipement. Ⓜ E80

This transmitter must not be co-located or operating in conjunction with any other antenna or transmitter.

The device is restricted to indoor use only and can be operated within 2412MHz to 2462MHz, 5180GHz to 5320GHz, 5500GHz to 5720GHz, and 5745GHz to 5825GHz. Selection of other channels is disabled. The device meets all the other requirements specified in Part E, Section 15.407 of the FCC Rules.

Radiation Exposure Statement

This equipment complies with FCC radiation exposure limits set forth for an uncontrolled environment. This equipment should be installed and operated with minimum distance 20 cm between the radiator and your body.

European Union Restriction of the Use of Certain Hazardous Substances (RoHS) in Electrical and Electronic Equipment

This Allied Telesis RoHS-compliant product conforms to the European Union Restriction of the Use of Certain Hazardous Substances (RoHS) in Electrical and Electronic Equipment. Allied Telesis ensures RoHS conformance by requiring supplier Declarations of Conformity, monitoring incoming materials, and maintaining manufacturing process controls.

Industry Canada Statement

This device contains licence-exempt transmitter(s)/receiver(s) that comply with Innovation, Science and Economic Development Canada's licence-exempt RSS(s). Operation is subject to the following two conditions:

- (1) This device may not cause interference.
- (2) This device must accept any interference, including interference that may cause undesired operation of the device.

L'émetteur/récepteur exempt de licence contenu dans le présent appareil est conforme aux CNR d'Innovation, Sciences et Développement économique Canada applicables aux appareils radio exempts de licence. L'exploitation est autorisée aux deux conditions suivantes:

- (1) L'appareil ne doit pas produire de brouillage.
- (2) L'appareil doit accepter tout brouillage radioélectrique subi, même si le brouillage est susceptible d'en compromettre le fonctionnement.

This Class B digital apparatus complies with Canadian ICES-003.

Cet appareil numérique de la Class B est conforme à la norme NMB-003 du Canada.

Caution:

- (i) the device for operation in the band 5150-5250 MHz is only for indoor use to reduce the potential for harmful interference to co-channel mobile satellite systems;
- (ii) the maximum antenna gain permitted for devices in the bands 5250-5350 MHz and 5470-5725 MHz shall be such that the equipment still complies with the e.i.r.p. limit;
- (iii) the maximum antenna gain permitted for devices in the band 5725-5850 MHz shall be such that the equipment still complies with the e.i.r.p. limits specified for point-to-point and non-point-to-point operation as appropriate; and
- (iv) the worst-case tilt angle(s) necessary to remain compliant with the e.i.r.p. elevation mask requirement set forth in Section 6.2.2(3) shall be clearly indicated.
- (v) Users should also be advised that high-power radars are allocated as primary users (i.e. priority users) of the bands 5250-5350 MHz and 5650-5850 MHz and that these radars could cause interference and/or damage to LE-LAN devices.

Avertissement:

Le guide d'utilisation des dispositifs pour réseaux locaux doit inclure des instructions précises sur les restrictions susmentionnées, notamment:

- (i) les dispositifs fonctionnant dans la bande 5150-5250 MHz sont réservés uniquement pour une utilisation à l'intérieur afin de réduire les risques de brouillage préjudiciable aux systèmes de satellites mobiles utilisant les mêmes canaux;
- (ii) le gain maximal d'antenne permis pour les dispositifs utilisant les bandes de 5250 à 5350 MHz et de 5470 à 5725 MHz doit être conforme à la limite de la p.i.r.e.;
- (iii) le gain maximal d'antenne permis (pour les dispositifs utilisant la bande de 5725 à 5850 MHz) doit être conforme à la limite de la p.i.r.e. spécifiée pour l'exploitation point à point et l'exploitation non point à point, selon le cas;
- (iv) les pires angles d'inclinaison nécessaires pour rester conforme à l'exigence de la p.i.r.e. applicable au masque d'élévation, et énoncée à la section 6.2.2.3), doivent être clairement indiqués.
- (v) De plus, les utilisateurs devraient aussi être avisés que les utilisateurs de radars de haute puissance sont désignés utilisateurs principaux (c.-à-d., qu'ils ont la priorité) pour les bandes 5250-5350 MHz et 5650-5850 MHz et que ces radars pourraient causer du brouillage et/ou des dommages aux dispositifs LAN-EL.

Radiation Exposure Statement:

This equipment complies with ISED radiation exposure limits set forth for an uncontrolled environment. This equipment is should be installed and operated with minimum distance 20 cm between the radiator and your body.

Déclaration d'exposition aux radiations:

Cet équipement est conforme aux limites d'exposition aux rayonnements ISED établies pour un environnement non contrôlé. Cet équipement doit être installés et utilisés avec une distance minimale de 20 cm entre le radiateur et votre corps.

UK - UKCA Declaration of Conformity

Hereby, Allied Telesis declares that the radio equipment type [AT-TQ6602 GEN2, AT-TQm6602 GEN2] is in compliance with the Radio Equipment Regulations 2017

Operating Frequencies and Maximum Transmission Power Levels

The operating frequencies and maximum transmission power levels for wireless devices operated in the UK are listed below:

AT-TQ6602 GEN2 and AT-TQm6602 GEN2

	Beamforming	Non-Beamforming
2412-2472 MHz	19.87 dBm	19.94 dBm
5150-5250 MHz	21.42 dBm	22.93 dBm
5250-5350 MHz	20.20 dBm	22.83 dBm
5470-5725 MHz	28.45 dBm	29.88 dBm

Note

Operations in the 5.15 - 5.35 GHz band are restricted to indoor usage only.

Radiation Exposure Statement

This equipment complies with EU radiation exposure limits set forth for an uncontrolled environment. This equipment should be installed and operated with a minimum distance of 20 cm between the radiator and your body.



Importer

Allied Telesis International BV
11 Pine Court, Kembrey Park Swindon Wiltshire SN2 8AD,
United Kingdom

Note

Contact Allied Telesis for the UK conformity statement. To contact Allied Telesis, visit our web site at www.alliedtelesis.com/contact.

Appendix C

Radiation Patterns

This appendix contains the following sections:

- “TQ6602 GEN2 and TQm6602 GEN2 Access points” on page 62

TQ6602 GEN2 and TQm6602 GEN2 Access points

Antenna Locations



Figure 32. Antenna Axes on the TQ6602 GEN2 and TQm6602 GEN2 Access Points

Axes on the Access Point

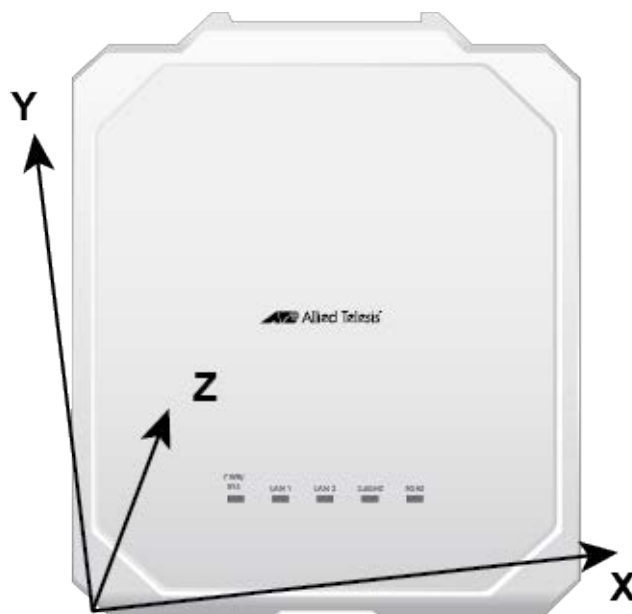
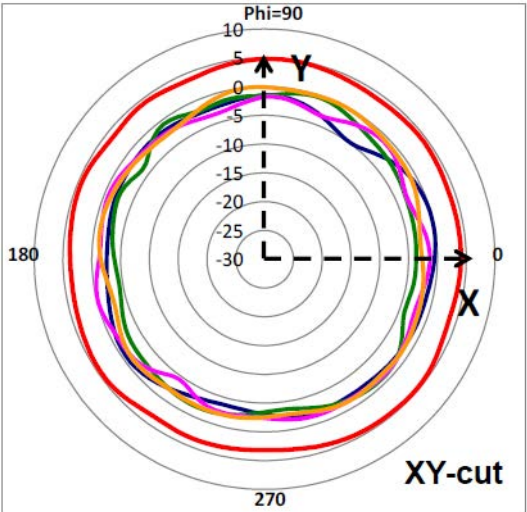
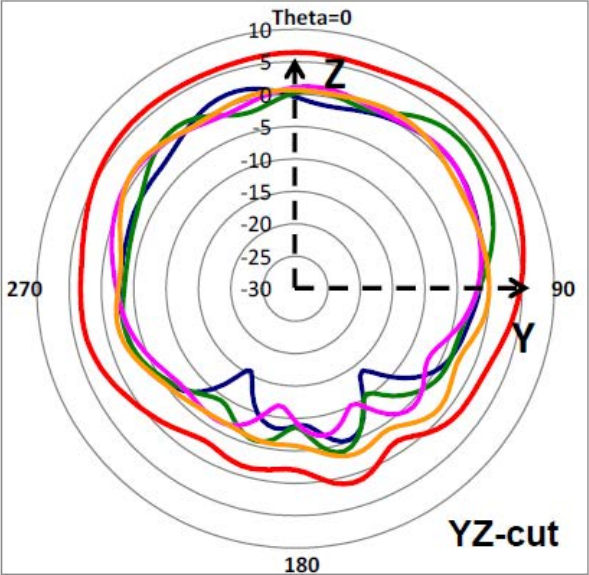
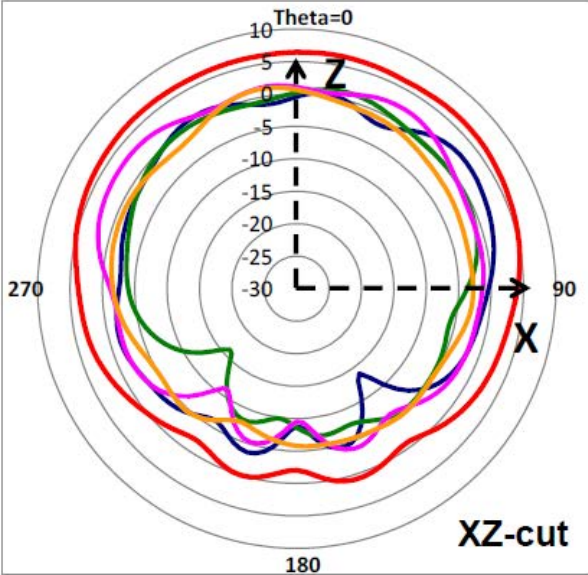

Figure 33. Axes on the TQ6602 GEN2 and TQm6602 GEN2 Access Points

4x4 2.4G

- Directional Gain
- Dual1
- Dual2
- Dual3
- Dual4



4x4 5G

- Directional Gain
- Dual1
- Dual2
- Dual3
- Dual4

